

Glass Passivated Super Fast Rectifiers
Reverse Voltage 50 to 1000 Volts Forward Current 10.0 Amperes

Features

- Low forward voltage drop
- High current capability
- High reliability
- High surge current capability

Mechanical Data

- Case : ITO-220AC Molded plastic
- Epoxy : UL 94V-O rate flame retardant
- Lead : Leads solderable per MIL-STD-202, method 208 guaranteed
- Polarity : As marked
- High temperature soldering guaranteed : 260°C/10 seconds
 /0.25",(6.35mm) from case
- Weight : 2.24 grams
- Mounting torque : 5 in-lbs. max.

Marking

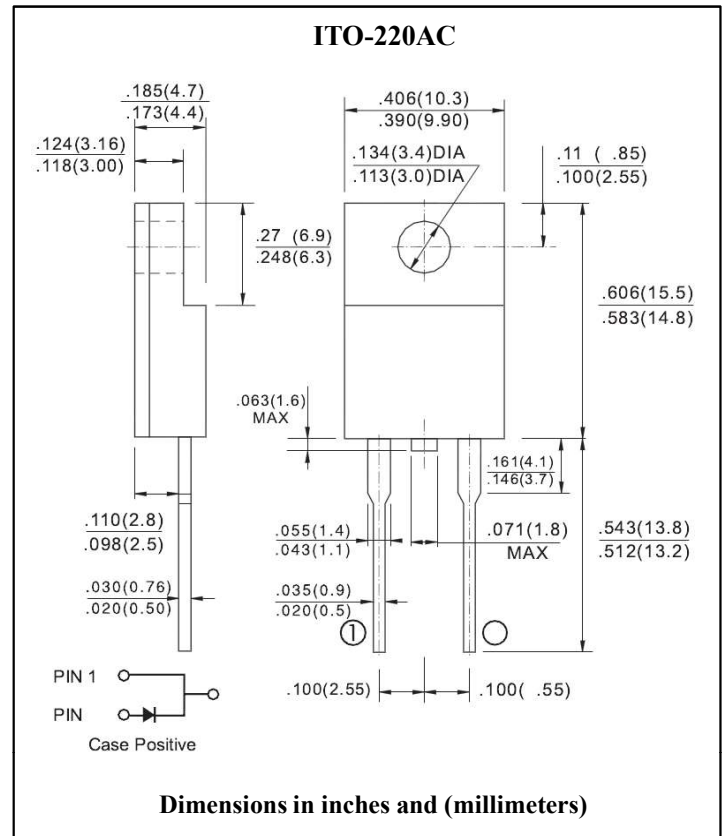
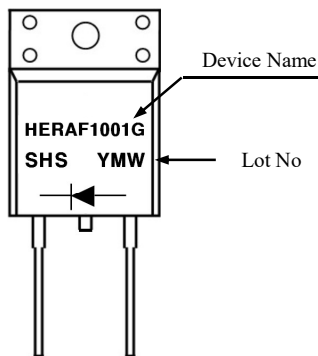

Maximum Ratings & Electrical Characteristics

Ratings at 25°C ambient temperature unless otherwise specified
 Single phase half wave 60 Hz, resistive or inductive load
 For capacitive load, derate current by 20%

Parameter	Symbol	HERAF 1001G	HERAF 1002G	HERAF 1003G	HERAF 1004G	HERAF 1005G	HERAF 1006G	HERAF 1007G	HERAF 1008G	Unit	Remark
Maximum Repetitive Peak Reverse Voltage	V_{RRM}	50	100	200	300	400	600	800	1000	V	
Maximum RMS Voltage	V_{RMS}	35	70	140	210	280	420	560	700	V	
Maximum DC Blocking Voltage	V_{DC}	50	100	200	300	400	600	800	1000	V	
Maximum Average Forward Rectified Current 0.375"	$I_F(AV)$	10								A	
Peak Forward Surge Current, 8.3 ms Single Half Sine-wave Superimposed on Rated Load (JEDEC Method)	I_{FSM}	150								A	
Maximum Instantaneous Forward Voltage @ 10A	V_F	1.0			1.3		1.7			V	
Maximum DC Reverse Current at Rated DC Blocking Voltage	I_R	10								uA	Ta=25°C
		400								uA	Ta=125°C
Maximum Reverse Recovery Time	t_{rr}	50				80				ns	Note 1
Typical Junction Capacitance	C_j	80				60				pF	Note 2
Typical Thermal Resistance	$R_{th(j-c)}$	2.0								°C /W	Note 3
Operation Junction Temperature Range	T_j	-55 to +150								°C	
Storage Temperature Range	T_{STG}	-55 to +150								°C	

Note 1. Reverse Recovery Test Conditions : $I_F=0.5A$, $I_R=1.0A$, $I_{RR}=0.25A$
 Note 2. Measured at 1MHz and Applied Reverse Voltage of 4.0Volts D.C.
 Note 3. Mount on Heatsink Size of 2in × 3in × 0.25 in Al-Plate.



Ratings and Characteristics Curves (Ta=25°C unless otherwise noted)

Fig.1 Forward Current Derating Curve

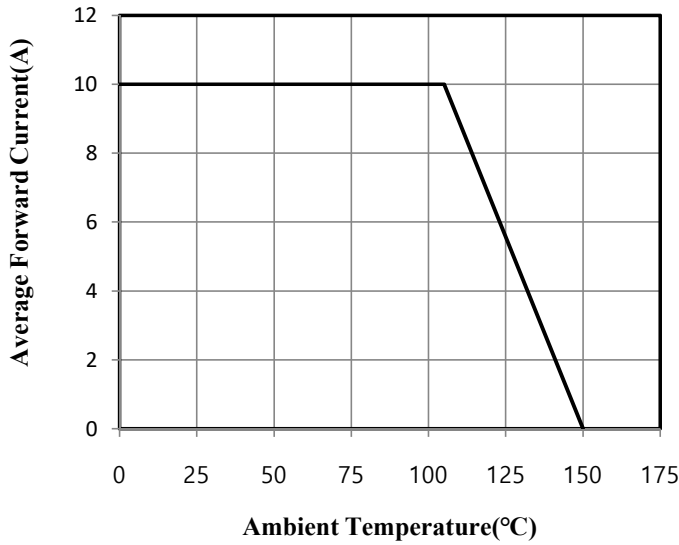

Fig.2 Maximum Non-Repetitive Peak Forward Surge Current

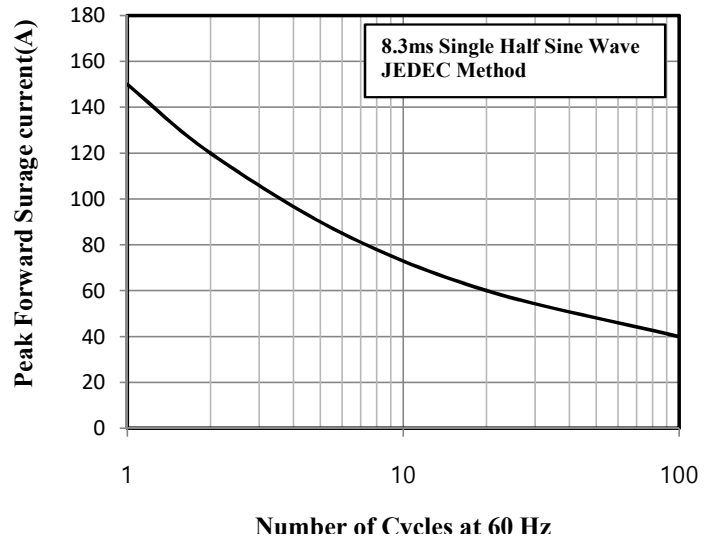

Fig.3 Typical Instantaneous Forward Characteristics

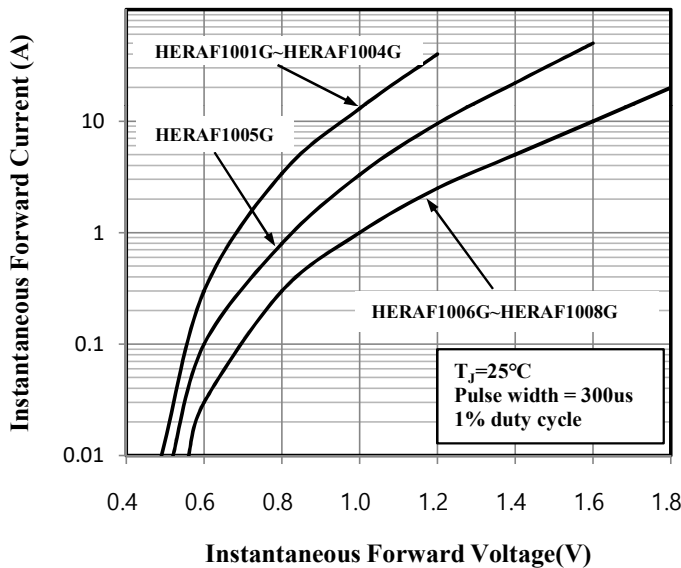

Fig.4 Typical Junction Capacitance

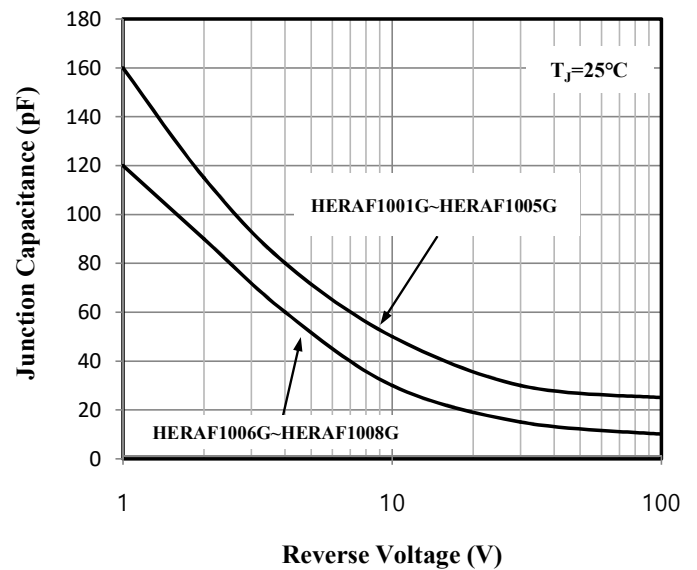

Fig.5 Typical Reverse Characteristics

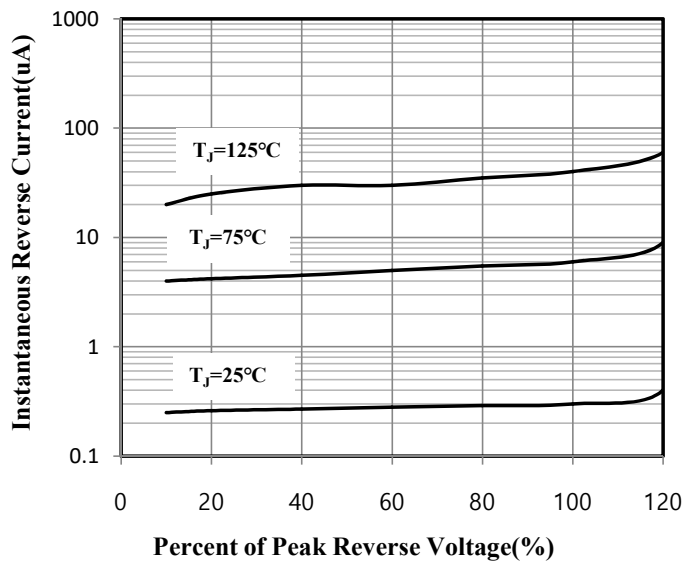

Fig. 6 Reverse Recovery Time Characteristic and Test Circuit Diagram

